



Microwave Harmonic Generation and Nanosecond Pulse Generation with the Step-Recovery Diode

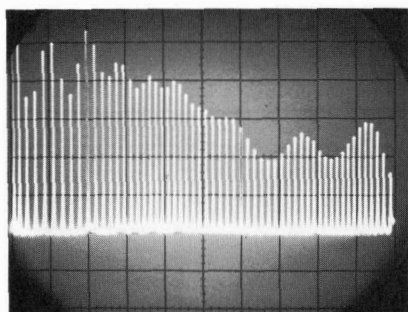

Fig. 1. Oscilloscope showing portion of a harmonic spectrum available from a typical Step Recovery Diode. Harmonics generated by 50 Mc driving signal (Fig. 5) and singly detected by square-law detector.

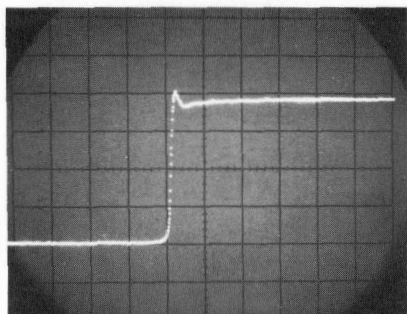

Fig. 2. Oscilloscope of very fast step (300 picoseconds) formed using Step Recovery Diode to steepen pulse-front as described in text. Pulse amplitude here is 4 volts.



Fig. 3. Step Recovery Diodes in glass and ceramic packages. Ceramic package is designed to be especially useful with coaxial structures but can also be used in other ways as in Fig. 8.

-hp-'s affiliate, **hp associates**, was established four years ago to perform research, development and manufacturing in the semiconductor field. After beginning with the development of specialized silicon, germanium, and gallium arsenide diodes, **hpa** has gone on to achieve industry leadership in metal-on-semiconductor ("hot carrier") technology and is

contributing to the advance of the art in optoelectronics and solid-state microwave devices.

One of **hpa's** developments having general interest to design engineers is the Step Recovery Diode. This device has made possible advances in fast pulse work and is unique as an efficient generator of high-order harmonics. These capabilities are described in the following article.

ANY *p-n* junction semiconductor diode can be made to conduct heavily in the reverse direction for a brief time immediately following forward conduction. This momentarily augmented reverse conductivity results from the presence of stored minority carriers which had been injected and stored during forward conduction. In the past such reverse storage-conduction has been considered as detrimental in many applications, and so-called "fast-recovery diodes" were developed to reduce it.

Recently, *hp associates* developed a very different class of semiconductor diodes. These were designed to enhance storage and to achieve an abrupt transition from reverse storage-conduction to cutoff. The abruptness of this transition is such that it can be used to switch tens of volts or hundreds of milliamperes in less than a nanosecond. Such a combination of switching speed and power-handling range is not possible with any other existing device. It enables the diodes to generate milliwatts of power at X-band or to provide fast pulses at amplitudes of tens of volts across 50 ohms. As power generators, the diodes will generate high-order harmonics in the microwave region with greater efficiency and simplicity than is possible by any other means. In pulse work, the diodes will generate fractional-nanosecond pulses in which amplitude and timing can be freely controlled, as described in the latter

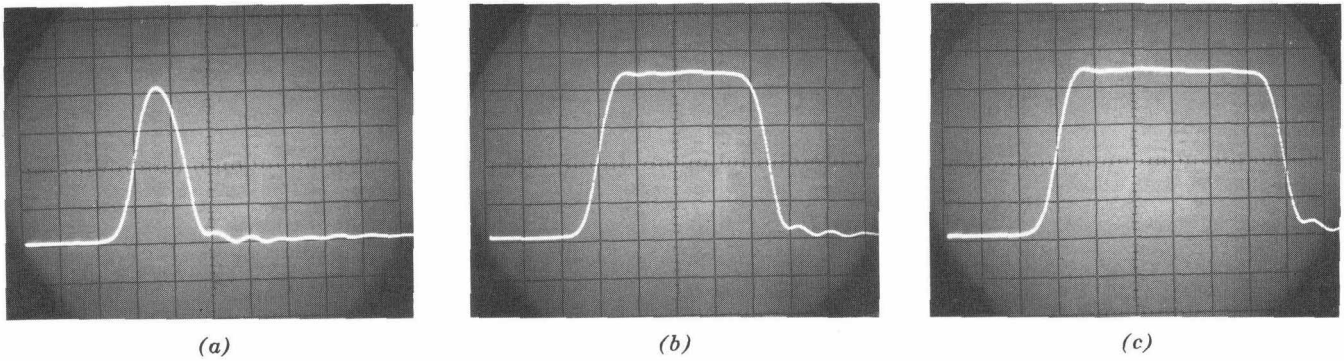

Fig. 4. Examples of fast pulses of appreciable amplitude generated with Step Recovery Diodes. Pulse height is about 8 volts (2 v/cm). Sweep time is 1 nsec/cm.

part of this article. Figs. 2 to 4 indicate the high multiplication factors and fast-pulse application of the diodes.

Because their conductance during reverse storage conduction follows a step function, these diodes have been termed "Step Recovery Diodes" by *hpa*. They are also known as "snap-off" or "charge-storage" diodes. Their step-recovery characteristic is illustrated in the oscillogram of Fig. 5 which shows the diode current while the diode was excited by a 50-megacycle sinusoid. In the forward direction the diode conducts in a conventional way. As the excitation becomes negative, however, the diode current also reverses until the supply of stored minority carriers becomes exhausted. At this point cessation of reverse current occurs very rapidly—in less than a nanosecond—resulting in a fast current step that is rich in harmonics. In fact, harmonics to above the 100th can be obtained at

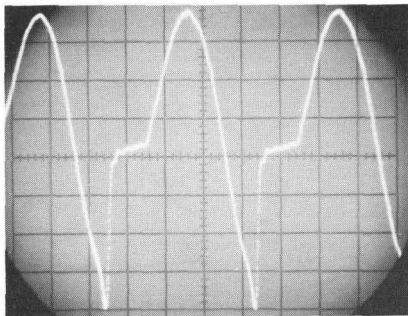

Fig. 5. Oscilloscope of current through a Step Recovery Diode when driven by a sine wave (50 Mc). Abrupt transition on negative half-cycle occurs when stored charge becomes depleted and is an efficient mechanism for generating harmonics (Fig. 1).

power levels approaching a milliwatt if not higher.

In practical work the diodes can be used in a single-stage multiplier to produce harmonics in the microwave region with a simplicity and freedom from noise unmatched by other arrangements or by conventional harmonic-generating diodes such as varactors. The presently-known state of the art in high-order multiplication with the Step Recovery Diode is shown in Table I. The variation in performance from band to band presumably results from various degrees of design effort.

Even the performance shown in Table I is expected soon to become obsolete as a result of work in progress at *hp associates* and elsewhere. Step Recovery Diodes should soon become available which will be capable of approaching 1 watt in the 1 to 2 Gc range and 50 to 100 milliwatts in the 8 to 12 Gc range.

In harmonic-generating work the high efficiency of the Step Recovery Diode compared to conventional diodes occurs because of the basically-different generating mechanism involved in the two cases. Conventional diodes, such as varactors, are operated within their reverse saturation region so as to avoid both forward conduction and avalanche breakdown. Under these conditions the diode acts as a voltage-variable capacitor having some dissipation. The resulting capacitance-voltage characteristic is smooth and thus does not generate appreciable high-order harmonic power. For such diodes the conversion efficiency in this mode

is usually found to decrease approximately at the rate of $1/n^2$, where n is the harmonic number. For this reason efficient harmonic generation with varactors usually requires a cascade of doublers and triplers with attendant idlers and complications.

Variable-resistance (point-contact) diodes also suffer from poor efficiency when used for other than small multiplication factors. Tube multipliers, of course, are noisy and unstable among other disadvantages.

On the other hand, the Step Recovery Diode has a reverse-bias capacitance that varies only slightly with bias voltage. The contribution of this mechanism to harmonic generation is thus negligible, and the step-recovery mechanism is the important one. Fur-

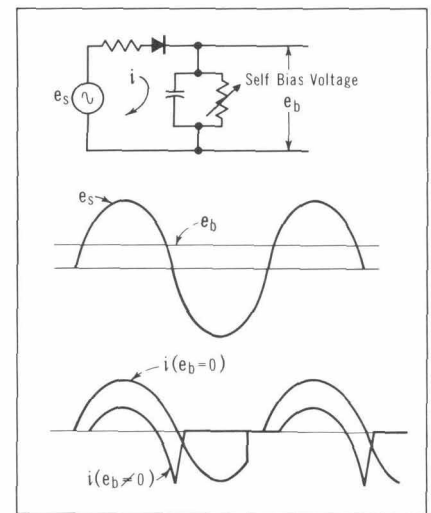

Fig. 6. Drawing showing how level of bias affects the amplitude of the diode current discontinuity and thus the efficiency of harmonic generation.

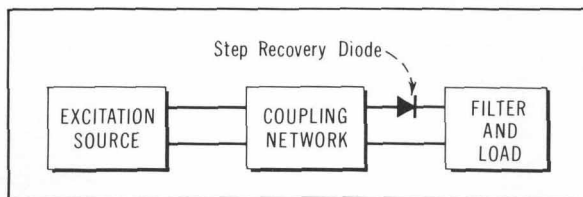

Fig. 7. Functional block diagram of harmonic multiplier.

ther, the output power of the Step Recovery Diode can be shown by Fourier analysis to decrease only as $1/n$ when n is larger than 5. As a result, the Step Recovery Diode is the most practical means available for generating moderate-power harmonics and is probably the only practical means for generating high-order harmonics.

DIODE BIAS

Bias is required for these diodes in harmonic generators because they would otherwise conduct during the entire drive-frequency cycle and no electrical discontinuity would be produced. Under bias, however, and with lifetime much longer than the excitation period, the time integral of forward current will be slightly larger than that of the reverse current. A large discontinuity may then be produced when conduction ceases, as shown in Fig. 6. In a circuit that is optimized for efficient harmonic generation, the current waveform may not be as simple as is indicated in this figure since strong oscillatory components will be supported, and the conduction angle will be strongly influenced by the reactance elements that are present.

HARMONIC MULTIPLIER DESIGN

The functional block diagram of a single-stage multiplier is shown in Fig. 7.

The design of the Step Recovery Diode harmonic generator circuit should:

1. Resonate the diode at the output frequency.
2. Provide a broadband reactive termination for unwanted harmonics.
3. Match input power down to the diode impedance ($1-10\Omega$).
4. Tune out the circuit susceptance at the input frequency.

5. Provide high Q energy storage at the output frequency.

6. Provide appropriate bias for the diode, as described above.

These criteria are met by either of the two designs shown in Figs. 9 and 10. In Fig. 9, a broadband input circuit is utilized to permit making changes in frequency without retuning the input. Fig. 10 shows a resonant input circuit which is simpler for fixed frequency applications and still decouples harmonics efficiently from the source. In either circuit self-bias of the diode is satisfactory, but in some applications it may be desirable to use fixed bias, and to control the bias resistance.

The diode in its associated package and the output circuit should be res-

onant at the output frequency, a condition normally difficult to calculate since it depends upon geometric details of diode mounting, the diode parameters, the output circuit and the driving reactance. The diode should not be resonant at other harmonic frequencies. In practice one usually provides some reactive tuning device at the diode to adjust for best operation. One such device is shown in Fig. 11.

Energy storage at the output frequency is needed to develop voltage on the diode for maximum efficiency and to eliminate undesired adjacent harmonics. In the examples of Figs. 9 and 10, a double-tuned, quarter-wave-stub, iris-coupled cavity is indicated. Any of many other configurations of waveguide coaxial cavity could be used.

TABLE I. PRESENT STATE OF THE ART IN HIGH ORDER MULTIPLICATION WITH STEP RECOVERY DIODES

F_{out} (Gc)	Multiplication order (n)	Maximum P_{out} (mw)	Conversion Loss (db/n)
1- 2	10-30	200	0.5
2- 4	10-30	100	0.75
4- 8	10-40	50	1.0
8-12	9-84	20	1.5

hpa STEP RECOVERY DIODES HARMONIC GENERATION APPLICATIONS TYPICAL PERFORMANCE

hpa Diode Numbers	Upper Freq.	Output Power	Configuration
0112, 0113, 0114	3 Gc	Milliwatts	Glass
0151, 0152, 0153, 0154	10 Gc	Milliwatts	Glass
0251, 0252, 0253, 0254	10 Gc	Milliwatts	Ceramic

PULSE-SHAPING APPLICATIONS TYPICAL PERFORMANCE

hpa Diode Numbers	Rise and Fall Time	Pulse Amplitude	Configuration
0151, 0152, 0153, 0154	<0.25 nsec	5v, 50 ohms	Glass
0251, 0252, 0253, 0254	<0.25 nsec	5v, 50 ohms	Ceramic
0102, 0103	<0.5 nsec	10v, 50 ohms	Glass
0112, 0113	<1 nsec	10v, 50 ohms	Glass

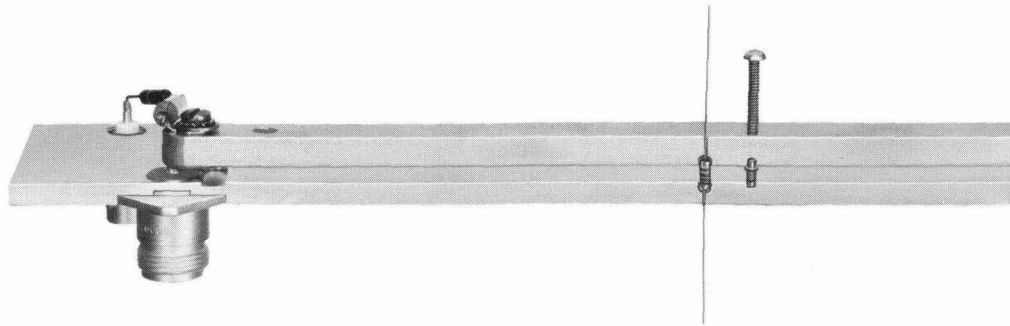

Fig. 8. Broadband stripline circuit used in bench work with Step Recovery Diode. Either glass or ceramic style diodes can be accommodated as shown.

The cavities should have high Q to reduce insertion loss at the desired output frequency while simultaneously eliminating adjacent harmonics. An alternative description of the requirement is to say that enough energy should be stored so that it is not depleted appreciably by the load in the interval between impulses from the drive frequency. This means suppressing the AM modulation of the output at the drive frequency. The degree of suppression desired will depend upon the application and will determine the amount of output filtering required. To reduce neighboring sidebands in a X20 multiplier by 20 db, for example, a loaded Q of about 300 is needed.

Adjustment of multipliers using the Step Recovery Diode is a simple procedure. The output resonator should be pre-aligned to resonate at the proper frequency, and the input frequency and power level set. The diode self-bias resistance, the output circuit resonance with the packaged diode, and the input matching circuit are

then adjusted for maximum power output and efficiency.

Additional application information is given in the *hpa* Application Note "Harmonic Generation with Step Recovery Diodes."

A TYPICAL SINGLE-STAGE X20 MULTIPLIER

A single-stage X20 Step Recovery Diode multiplier was designed using the principles previously cited. An efficiency in excess of 10%, or $2/n$ where n is the harmonic number, was achieved by this technique using various *hpa* Step Recovery Diodes. The circuit of the multiplier and associated filter are shown schematically in Fig. 12.

The Step Recovery Diode is placed in series with the input resonator which is of the shorted type. The only adjustment of the diode reactance and microwave circuit impedance required is by use of the sliding short shown in the figure. The 2000 Mc output filter is a six-resonator interdigital structure with a bandwidth of 20 Mc and a 2 db

insertion loss. The estimated total circuit losses of the circuit described are approximately 2.5 to 3 db.

The operation of the circuit is simple and replacing a diode requires a minimum of retuning time to achieve a stable maximum output power. The tuning requires only that the variable resistor and capacitor be adjusted for best input match and the sliding short be positioned for maximum output power.

Various *hpa* Step Recovery Diodes were substituted in this X20 multiplier and Table II shows a summary of the average experimental results obtained with the different types of diodes. In addition, single-stage X16 multipliers have been built which have conversion efficiencies greater than 20% and outputs greater than 100 mw at 1.5 Gc. At 10 Gc output levels in excess of 20 mw have been obtained when driven by 1.25 Gc.

DIODE SELECTION

With respect to Step Recovery Diode requirements for efficient harmonic

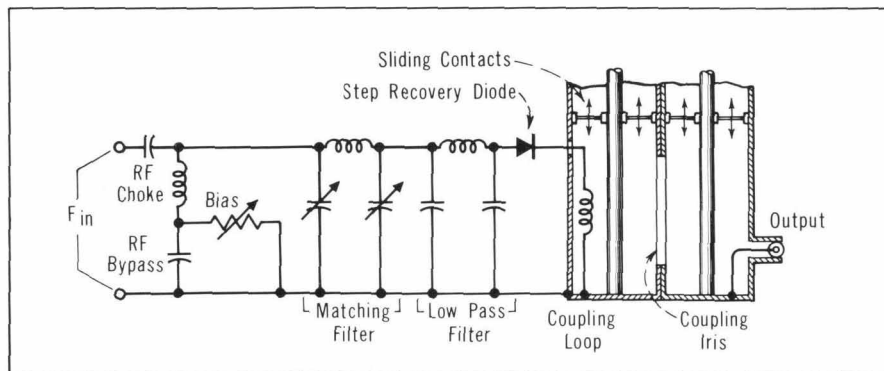

Fig. 9. Basic circuit of a broadband type harmonic generator.

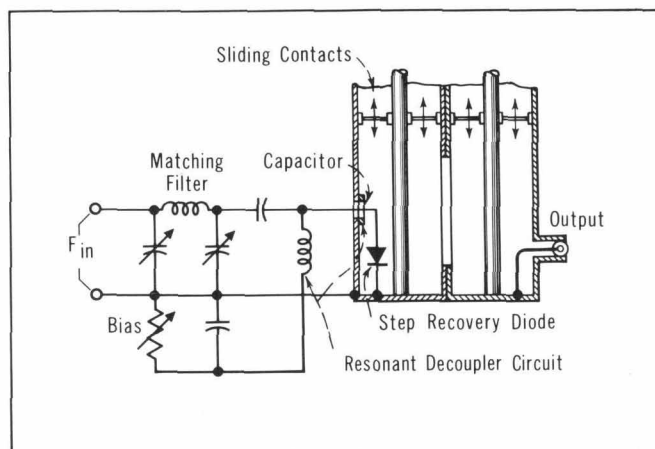

Fig. 10. Basic circuit of a single-frequency harmonic generator.

generation, it is usually desirable that the minority carrier lifetime τ be at least three times the period of the excitation frequency, and that the transition time t_t be shorter than $1/2$ the period of the output frequency. A long value of τ allows for a large amount of stored charge for conversion to harmonic power. It also simplifies establishing appropriate bias conditions for the diode.

The conversion efficiency depends on the speed and amplitude of the transition time t_t . Step Recovery Diodes with transition times less than one-half of the period of the desired output frequency achieve efficiencies in excess of $1/n$. The efficiency increases as the transition time becomes short compared to the period of the output frequency until it is one-tenth or less. Although theoretical predictions other than the 100% efficiency permitted by the Manley-Rowe rela-

tions are lacking, diode efficiencies up to 30% have been achieved experimentally in the previously cited X20 multiplier.

The probable practical limit of efficiency for high-order multiplication obtained by extrapolating data to the limit of zero transition time is approximately 40%.

Fig. 13 shows the efficiency obtained using the *hpa* X20 multiplier from a 100 Mc input to a 2000 Mc output.

TABLE. II. AVERAGE OPERATING RESULTS
X20 MULTIPLIER

Input Frequency 100 Mc — Output Frequency 2000 Mc		
<i>hpa</i> Diode Type	P_{out} (mw)	Diode Conv. Eff. (%)
0112	20	15
0151, 0251	5	25
0152, 0252	5	20
0153, 0253	15	30
0154, 0254	15	15
0132	80	10

The efficiency at the diode is plotted against transition time t_t which is measured in units of the period T of the output frequency. The region $t_t/T < 0.2$ is extrapolated. Approximately 40 different diodes were used to obtain the data for this graph. Data on many more diodes in C-band multipliers confirm the general relation shown here.

For a given output frequency, it is also desirable to select a diode with the

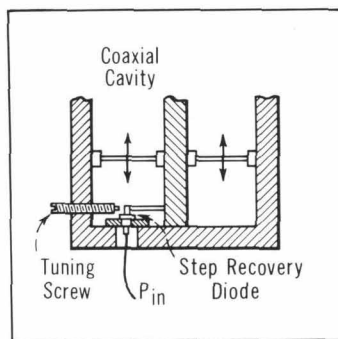

Fig. 11. Drawing showing use of tuning screw to resonate Step Recovery Diode at desired output frequency.

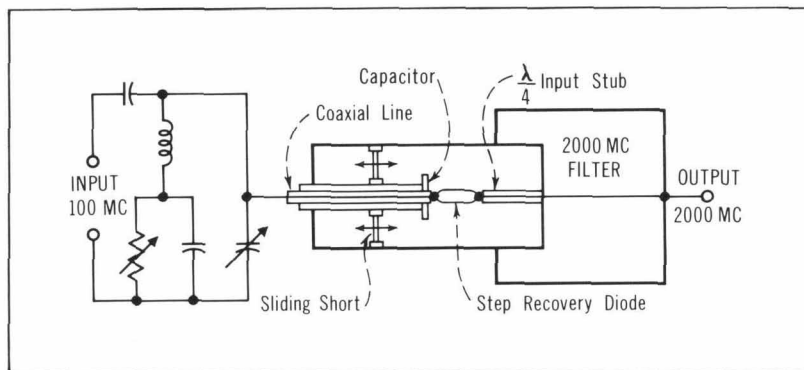

Fig. 12. Basic circuit of a X20 harmonic multiplier using a Step Recovery Diode providing a 2000-Mc output at the efficiencies shown in Table II.

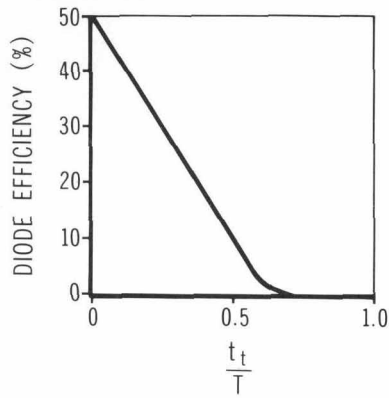

Fig. 13. Efficiency of multiplier in Fig. 12 as a function of diode transition time.

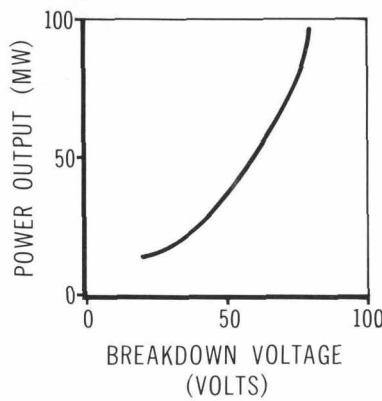

Fig. 14. Power output of multiplier in Fig. 12 as a function of diode breakdown voltage.

lowest values of diode series resistance R_s and junction capacitance C_j to achieve good circuit efficiency.

The effect on power output of diode breakdown voltage and of input drive level in a particular harmonic multiplier are shown in Figs. 14 and 15.

PULSE SHAPING AND GENERATION

In fast pulse work its unique char-

acteristics make the Step Recovery Diode a very important device. It can be used to square the rise and fall of fast pulses or to produce short, fixed delays. Impulses, in turn, can be generated from the fast pulses.

The value of the diodes in fast pulse work arises from a combination of their fast transition times, which are presently less than 100 picoseconds,

and the large voltage which they can switch—more than 10 volts at 50 ohms. No other device presently offers this speed, amplitude variation, and convenience.

PULSE-FRONT SQUARING

Fig. 17 shows several basic circuits using the Step Recovery Diode for pulse-front squaring, for generating fixed delays, and for trailing-edge squaring. Fig. 17 (a) shows a basic circuit for pulse-front squaring in which the diode is placed in shunt with the load. It can be seen from this circuit that, following the application of the driving pulse which acts as a reversing current, the diode will reverse-conduct for a period of time. It then abruptly exhausts its stored minority carriers so that the abrupt transition to cutoff occurs, thereby generating a step in current and voltage. This step can now be used as the sharpened front of the output pulse. Very fast output pulse rise times of a fraction of a nanosecond can be generated by this means in one or more stages, depending upon the speed of the driving pulse. Sufficient

DESIGN LEADERS

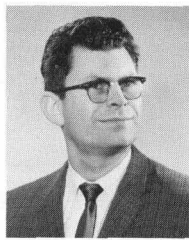

Robert D. Hall

Bob Hall joined **hpa** in 1963 to work on an advanced program concerned with integrated microwave semiconductor components. While at **hpa**, he has applied network synthesis techniques to obtain improved performance from diode switches, frequency multipliers, mixers and other components and has developed novel methods for constructing the necessary circuits. A member of the American Physical Society, Bob obtained a BA degree in Physics at Reed College and an MS degree in Mathematics at Stanford. Prior to joining **hpa**, he spent five years as a research engineer concerned with solid-state microwave components during which time he made important contributions to the theory of tunnel diode oscillators and amplifiers. He holds several patents.



Stewart M. Krakauer

Stew Krakauer joined the **-hp-** Oscilloscope Division in 1958 where he participated in the development of the **-hp-** Model 185A/187A Sampling Oscilloscope. He subsequently became head of applications engineering in the **-hp-** Semiconductor Laboratories and contributed to the development of other fast-switching and high-frequency circuits that use semiconductor devices. He transferred to **-hp- associates** in 1962 where he now heads the applications group. Stew earned a BSEE degree at Cooper Union and an MEE from Polytechnic Institute of Brooklyn. Prior to joining **-hp-**, he worked on electronic instrumentation as applied to inertial navigation and to physiological and radiological research.

bias current will generally be required to delay the transition until the applied pulse comes to a steady-state value.

Figs. 17 (b) and (c) show the use of fast-recovery diodes to avoid small pedestal voltages and dc offsets. In these circuits the fast-recovery diode isolates the load from the Step Recovery Diode until the voltage across the Step Recovery Diode has begun its transition. Fig. 17 (c) also shows the use of two stages to increase the speed of pulse-front squaring. Since the pulse rise time that is applied to the second stage is faster than the excitation pulse, less storage is required in the second-stage diode. Hence, its transition speed can be faster. The actual rise times will depend upon the impedance of the associated circuitry. However, tens of volts or hundreds of milliamperes can be switched by this arrangement with fractional nanosecond risetimes.

The voltage and current levels are established by the external circuit and are limited only by the reverse breakdown voltage of the diode and diode dissipation. Thus, the diode can switch many *watts* without exceeding its rated dissipation.

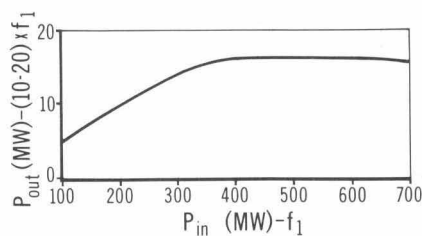

Fig. 15. Typical power output at 6000 Mc as a function of input power for a diode with 28-volt breakdown voltage. Multiplication of input frequency is from 10 to 20 times.

In addition to pulse-front squaring, the circuits can be used to generate impulses by differentiating the output pulse-front.

PULSE DELAY

In Fig. 17 (a) it can be seen that the time interval between the application of the drive pulse and the occurrence of the sharpened pulse-front will depend on the stored charge and hence on the forward bias current. Accordingly, this time interval can be varied from about 1 to 1,000 nanoseconds by varying the bias current. Thus, a convenient method is available for generating delay. The method is simple and has a sharply-defined end point. The effect of temperature changes on the delay can be compensated by mak-

ing the bias current suitably temperature-dependent.

TRAILING-EDGE SQUARING

To square the trailing edge of pulses, the Step Recovery Diode can be placed in series with the load, as shown in Fig. 17 (d). Very fast trailing edges are thus possible. Combinations of leading- and trailing-edge squaring can be used to obtain square, fast pulses, as shown in Fig. 4.

GENERAL

The Step Recovery Diode is unique in its efficient conversion of power up to high harmonic order in a single stage. It exceeds the performance of the conventional varactor diode because its functional non-linearity is

SPECIFICATIONS													
TYPICAL													
hpa													
STEP RECOVERY DIODES													
Sym.	Characteristic	hpa 0103		hpa 0106		hpa 0112		hpa 0151		hpa 0253		Units	Test Conditions
		Min.	Typ.	Max.	Min.	Typ.	Max.	Min.	Typ.	Max.	Min.		
τ	Lifetime	250	500	0.5	1.0	50	130	10	60	10	60	ns	
t_i	Transition Time		5.0		100	200	300	100	150	100	150	ps	
C_o	Capacitance		20.0		1.5		3.0	1.0	1.6	0.5	1.1	pf	$V_R = 0 V, f = 1 mc$
BV_R	Breakdown Voltage	20		32		35		15		25		V	$I_R = -10 \mu A$
I_R	Leakage Current		100		0.5		50		10		10	na	$V_R = -10 V, T_A = 25^\circ C$
I_F	Forward Current	100		100		150		40		25		ma	$V_F = 1.0 V$
L	Inductance		4.0		0.5		4.0		3.0		0.5	nh	
	Package	Std. Glass		Ceramic		Std. Glass		Small Glass		Ceramic			
	Unit price (1 and 100 lots)	\$18.75; \$14.00		\$75.00; \$50.00		\$18.75; \$14.00		\$25.00; \$16.70		\$125.00; \$85.00			

Specifications on other hpa diodes available on request.
Data subject to change without notice.
Prices f.o.b. factory.

hp associates
620 Page Mill Road
Palo Alto, California 94304
(415) 321-8510

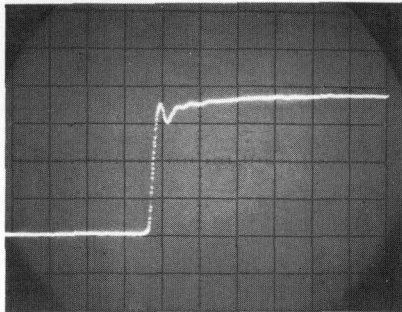

(a)

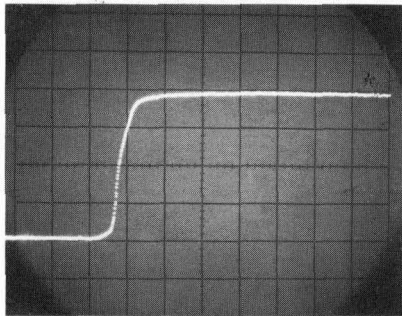

(b)

Fig. 16. (a). Very fast step (200 picoseconds) obtained with Step Recovery Diode; (b) driving step. Sweep time 2 nsec/cm.

greater. It also has the distinct advantage over all other multiplying techniques that it is attractively simple. It can accomplish in a single stage what requires a series of stages of other multipliers and does so without the complexity and complication of idlers and with very little parametric up-conversion of noise.

In pulse applications the diode can be used to achieve pulses with a combination of speed and amplitude not obtainable with other devices.

ACKNOWLEDGMENT

Several people have contributed to the design of the hpa Step Recovery Diodes, but the undersigned wish to cite particularly the contributions of M. M. Atalla and Mason A. Clark.

—Robert D. Hall and
Stewart M. Krakauer

REFERENCES

- ¹ S. Krakauer, "Harmonic Generation, Rectification, and Lifetime Evaluation with the Step Recovery Diode," Proc. IRE, Vol. 50, July, 1962.
- ² R. Hall, "Harmonic Generation with Step Recovery Diodes," hpa Application Note No. 2.
- ³ Moll, Krakauer, and Shen, "P-N Junction Charge Storage Diodes," Proc. IRE, Vol. 50, pp 43-53; January, 1962.

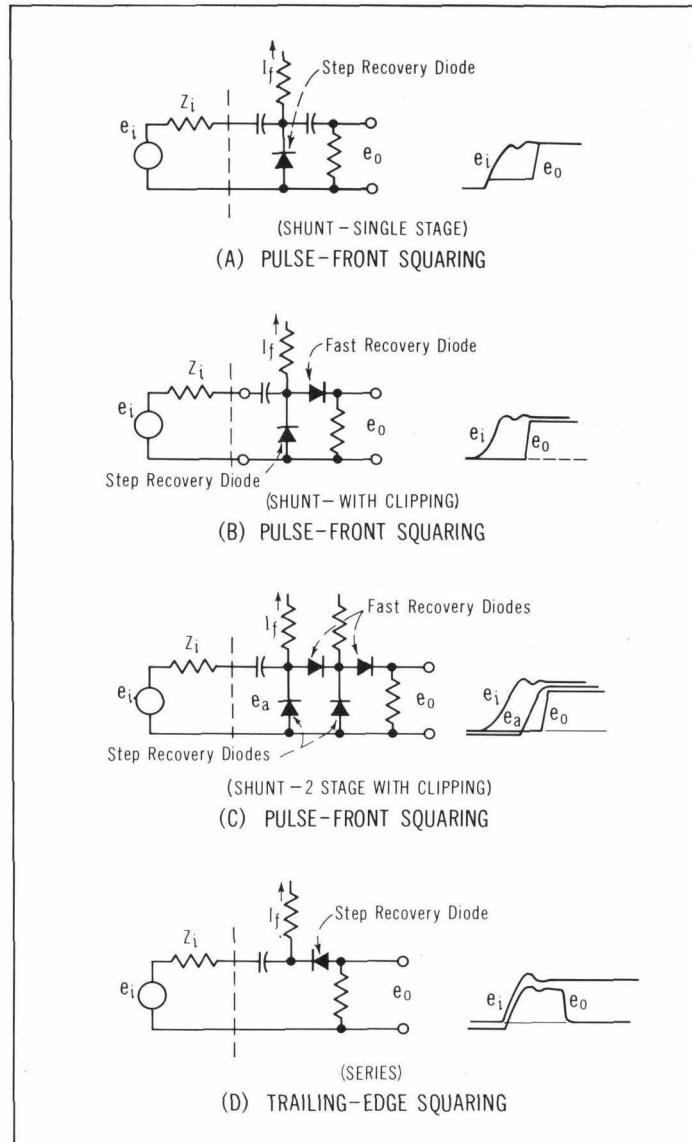

Fig. 17. Circuit arrangements using Step Recovery Diodes to sharpen leading and trailing edges of pulses and to obtain pulse delay.

hpa DIODE

APPLICATION NOTES

hp associates, —hp—'s affiliate which designs and produces the Step Recovery Diodes discussed in this issue, has prepared several application notes giving further information on these and other diodes. Titles are:

"Harmonic Generation with Step Recovery Diodes"

"Hot Carrier Diodes"
"The PIN Diode"
"The Hot Carrier Microwave Mixer Diode"

Any of these are available on request.

Address all requests as well as any and all questions concerning hpa devices directly to:

hp associates
620 Page Mill Road
Palo Alto, California 94304
(415) 321-8510